

METRIA

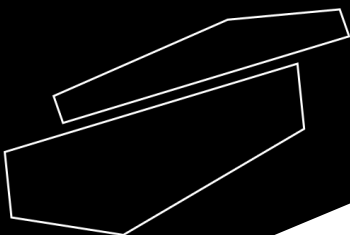

Analytical balance Metria, Plus

Please, read the User Manual carefully before use and follow all operating and safety instructions!



user manual

english

User manual



Analytical balance Metria, Plus

Preface

Users must read this manual carefully, follow the instructions and procedures, in order to be informed of all precautions before using the equipment, as well as to achieve maximum performance and longer equipment life.

Service

If help is needed, you can always contact your dealer or Labbox via:

www.labbox.com

Please, provide the customer service representative with the following information:

- Serial number (on the back side)
- Description of the problem
- Your contact information

Warranty

This instrument is guaranteed to be free from defects in materials and workmanship under normal use and service, for a period of 12 months from the date of invoice. The warranty is extended only to the original purchaser. It shall not apply to any product or parts which have been damaged on account of improper installation, improper connections, misuse, accidents, or abnormal conditions of operation. For claim under the warranty, please contact your supplier.

1. Introduction

The Metria analytical balance, operates using electromagnetic force compensation technology and a microprocessor that implements the speed, stabilization, and high resolution of the device. Widely used in various sectors such as scientific research, industry, and education.

2. Safety instructions

Please verify that the input voltage of the AC adapter matches the voltage of the local alternating current.

Place the balance on a flat, horizontal, and stable surface.

It should be used in dry ambient rooms, avoiding exposure to moisture.

For results with greater precision, install the equipment in a location with the optimal operating temperature specified in this manual.

Handle this device with care, gently adding samples to the center of the tray. Avoid rough handling to maximize the life of the balance.

3. Inspection

3.1 Unpacking

Unpack the equipment carefully and check for any damages that may have arisen during transportation. If necessary, contact your supplier for technical support.



Note:

If there is any apparent damage to the equipment, please, do not plug it into the power line.

3.2 Item list

Items	Quantity
Balance	1
Weighing pan	1
AC adapter	1
Glove (on external cal mod.)	1
Calibration weight (on external cal mod.)	1

Table 1

4. Main diagram

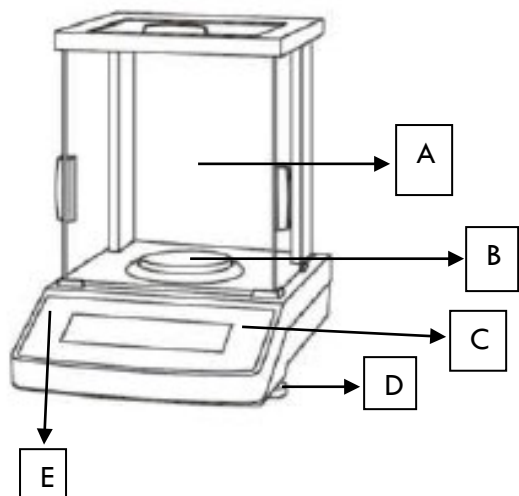









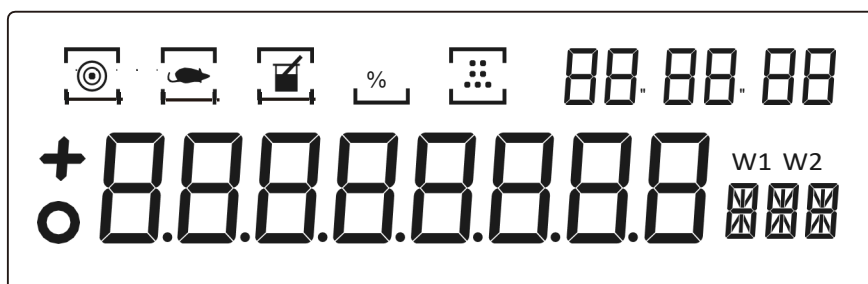



Windshield	A
Weighing pan	B
Control panel	C
Levelling feet	D
Level bubble	E

5. Control panel



6. Screen display



No.	Display	Description
1		Sensibility
2		Dynamic weighing
3		Density determination
4		Percent weighing
5		Piece counting
6		Time setting
7	WI	Weight in air
8	W2	Weight in liquid
9		Positive weight value
10		Negative weight value
11		Stable value
12		Progress bar
13		Unit display

7. Installation

- a. Place the balance on a stable surface. Adjust the 2 leveling feet on the bottom of the equipment until the bubble is centered in the circle, then install the weighing tray.

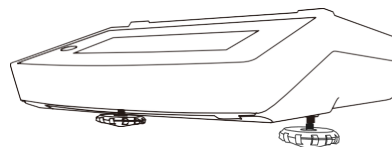
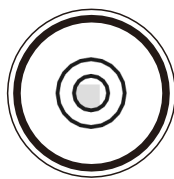
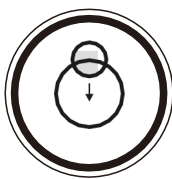

- b. Proceed to connect the balance to the AC adapter
c. Press "ON"

The device turns on with the weighing function by default and the display shows:



Note:

If the numbers on the screen are not stable when turning on the equipment, it may be due to temperature. Press "TARE" repeatedly and leave the equipment on for 30 minutes before using it.

If the ambient temperature varies significantly, leave the balance on for 120 minutes before using it.

8. Calibration

8.1 Calibration type selection

To obtain an accurate weighing result, the balance must be calibrated before the following usage scenarios:

- a. Before the first use.
- b. If the balance is turned off for an extended period or a power error occurs.
- c. After changing the operating environment.
- d. Regularly during the weighing procedure.

To select the type of calibration for the balance:

1. Press and hold the "ON" button until the screen displays "SET-C".

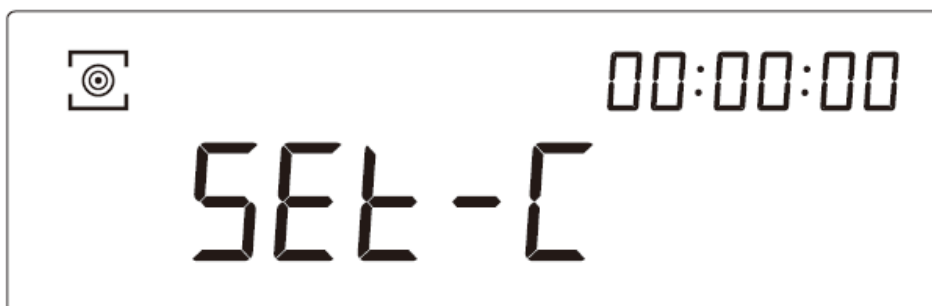

2. Press the "CAL" button until the desired calibration mode appears on the screen:

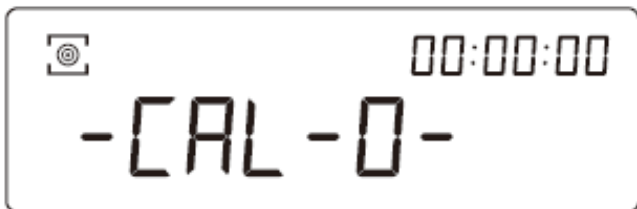

"CAL-0" External calibration (using calibration weight)

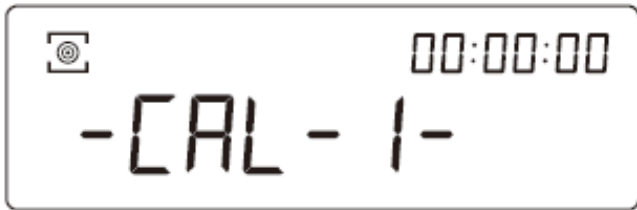

"CAL-1" Internal calibration (only for balances with internal calibration)

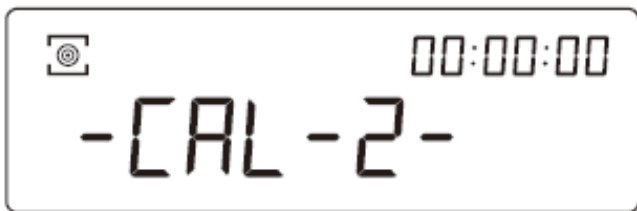

"CAL-2" Internal calibration weight value comparison (for internal calibration balances)

3. Press "TARE" to save and exit the configuration.

8.2 Calibration modes

To perform **"CAL-0" External Calibration (using calibration weight)**:

Press the "TARE" button until the following is displayed on the screen:



Press the "CAL" button to enter the calibration function that we selected in the previous step.

When the display shows CAL-0- (internally calibrated balances will calibrate automatically), for externally calibrated balances, the display will change from CAL-0- to CAL-200-



This indicates that we should place the 200 g standard weight (included) in the center of the weighing tray. When the display shows the exact stable result of the standard weight as "200.000", the calibration will be completed. You can then remove the weight and consider the calibration finished.

To perform "**CAL-1**" Internal Calibration (only for balances with internal calibration), we need to adjust the weight value.

Press the "TARE" button until the following is displayed on the screen:



Press the "CAL" button until the display shows "CAL-DN":

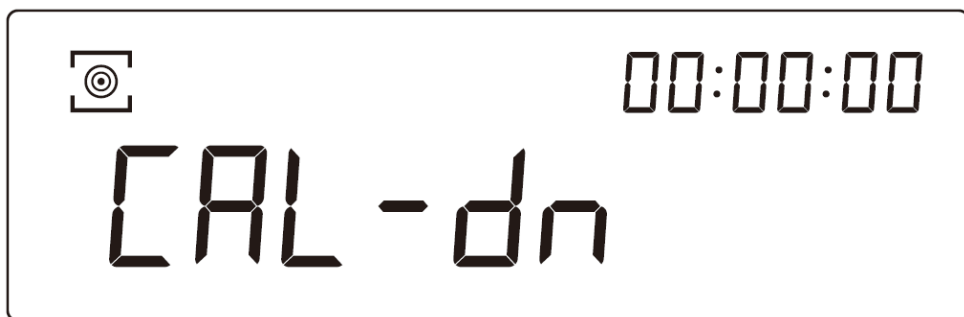

When the display shows "CAL-DN", place the standard weight on the tray. When the screen displays "CAL-UP", remove the weight.

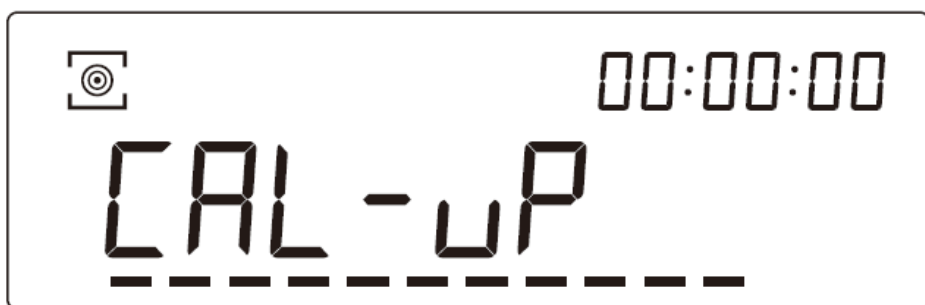

The process will be completed when the screen again displays:



To carry out **"CAL-2" Internal Calibration (only for balances with internal calibration)**, we need to adjust the weight value beforehand through the following process:

- a. Select "CAL-2" calibration

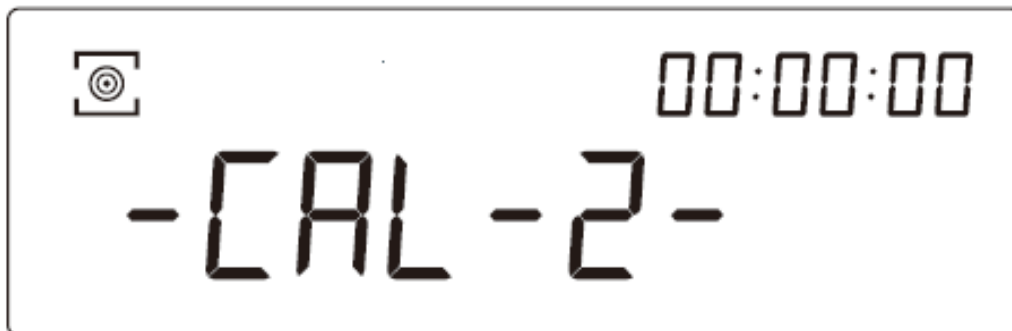

- b. Press the "CAL" button until "CAL-dn" is displayed on the screen

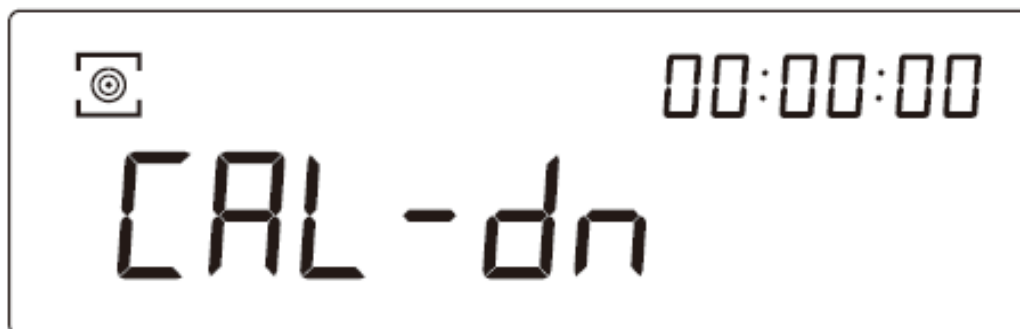

- c. Place the standard weight on the weighing tray and when the screen displays "CAL-UP," you may remove it.

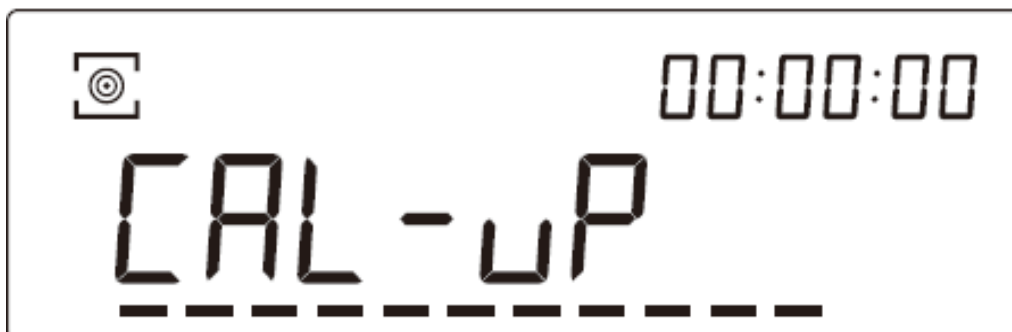

- d. Wait for the calibration to finish; the screen will display: "0.0000"



Linear calibration

When on the display :



- a. Press and hold the "ON" button, and the scale will enter the main menu. Wait until the screen displays "SET-C" to release the button.

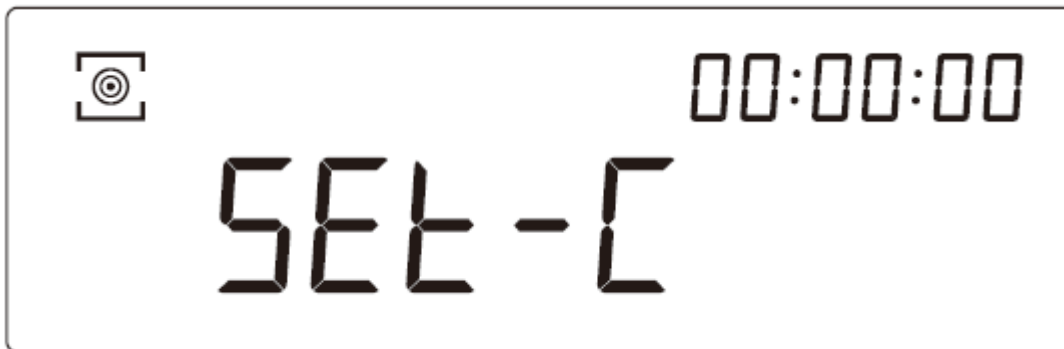

- b. Press and hold the "CAL" button for 3 seconds, and the screen will display "LIN-0"

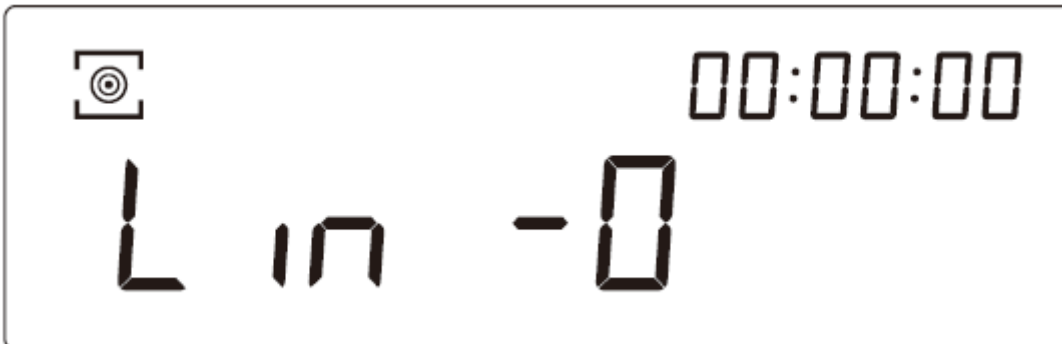

- c. Place the standard weight on the tray and complete the calibration process.

9. Operation

9.1 Unit conversion

With the weighing function active, press and hold the "PRINT" button to change the unit (g, oz, ct, mg)



9.2 Piece counting

9.2.1 Setting:

- a. With the weighing function active, press and hold the 'ON' button to enter the main menu until 'SET-0' is displayed on the screen, then release the 'ON' button.



- b. Press and hold the "PRINT" button to enter the sample quantity adjustment function in the "Piece Counter". On the screen, the following will be displayed:

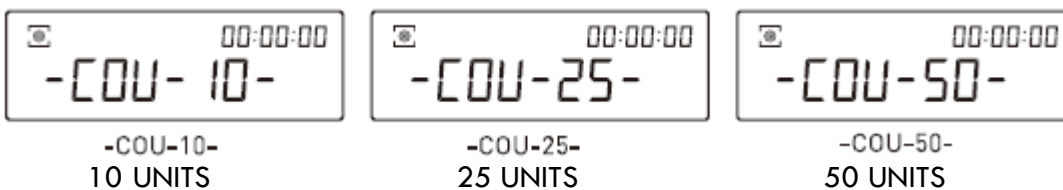

- c. Press "TARE" to save and exit

9.2.2 Function

- a. Press and hold the "PRINT" button with the weighing interface active. The screen will display "0 pcs" and  , release the "PRINT" button

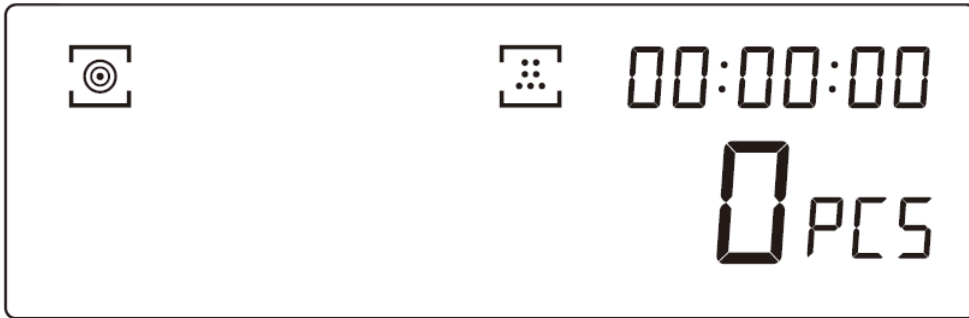

- b. Place the sample quantity you have set in SET-0.
c. Press the "ON" button to confirm the sample weight and start weighing.
d. If you test the same sample a second time, you will not need to resample.

9.3 Percent weighing %

- a. Hold the "PRINT" button with the weighing interface active. The screen will display "0.00" and  , release the button "PRINT"

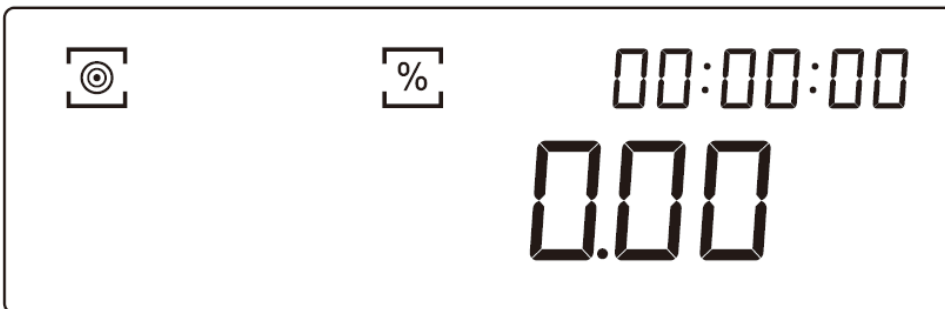

- b. Place the target sample on the tray (for example, a 100 g weight), press the "ON" button to save the sample weight, and the screen will display "100.00".
c. Put the target sample on the tray (for example, a 100g weight). The figure displayed on the screen is the percentage difference.

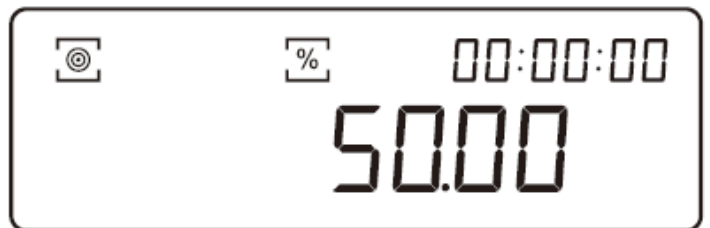
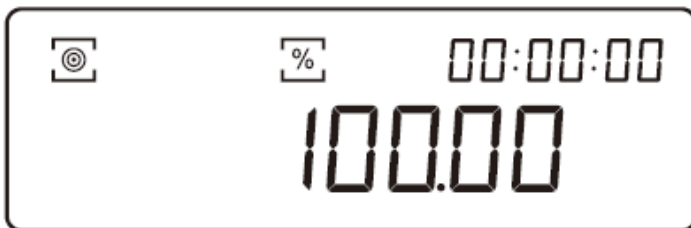

- d. If the same sample is used the second time, resampling is not necessary

9.4 Density Determination

It is necessary to have the accessory: density determination kit not included with the balance. To set it up, follow these steps:

- a. Press and hold the "ON" button, and the balance will enter the main menu. Wait until the screen displays "SET-d" to release the button.

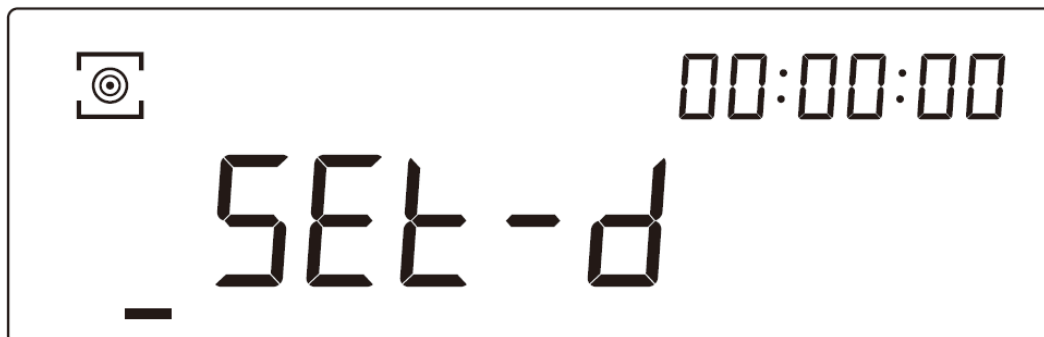

- b. Press and hold the "PRINT" button to enter the Density Determination parameter. The screen will display "-dEn*-".
- c. Press again and hold the "PRINT" button to configure the density determination. The screen will show you:



"-dEn-0-" closes the density determination mode.

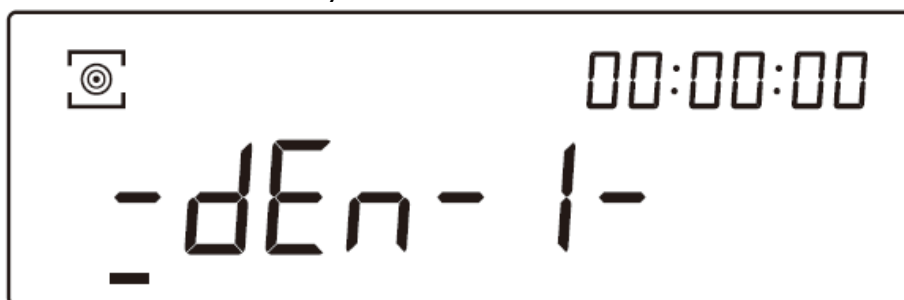

"-dEn-1-" opens the solid density determination mode.

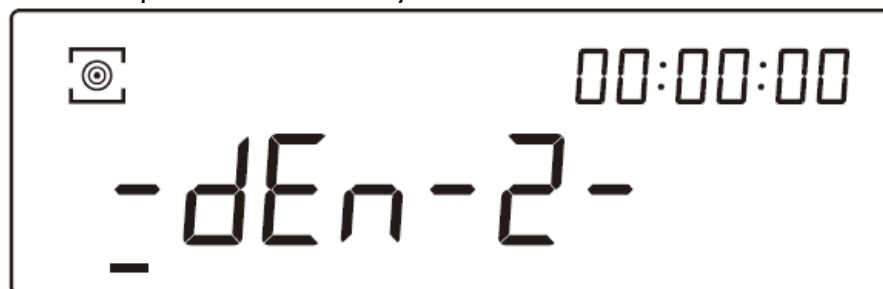

"-dEn-2-" opens the liquid density determination mode.

- e. Press "TARE" to exit and save the configuration, the screen will display "w1" in the bottom right corner.

9.4.1 Solid Density Determination (-dEn-1-)

a. Set the auxiliary value for the liquid density.

b. Press and hold the "ON" button under the symbol , the scale will enter the main menu and the text on the screen will change. When the following message "SET-d" appears, release the "ON" button.

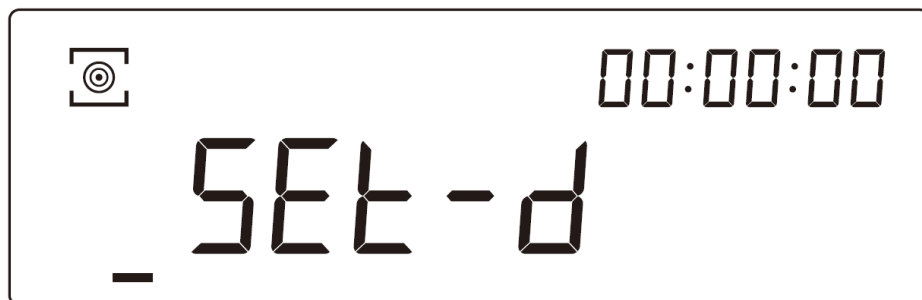

c. Press and hold the "CAL" button to enter the "auxiliary liquid density" configuration.

d. Press and hold the "CAL" button to increase the figure, or press and hold the "PRINT" button to decrease it.

e. Press the "TARE" button to save the density value and exit.

f. When "W1" is displayed on the screen, place the sample (see the screw in image (1)) on the tray "in the air" (part of the density determination kit accessory not included).

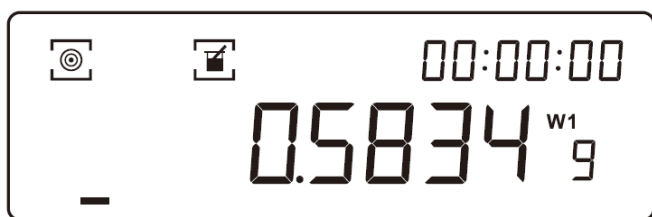

g. Press and hold "PRINT", and the screen will display W2

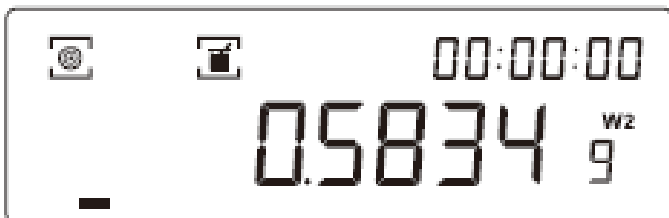

h. To weigh the sample in liquid (see the liquid in image (2)), hold "PRINT" to collect the data



i. The screen will display the density result (W1/W2 will no longer appear on the screen).

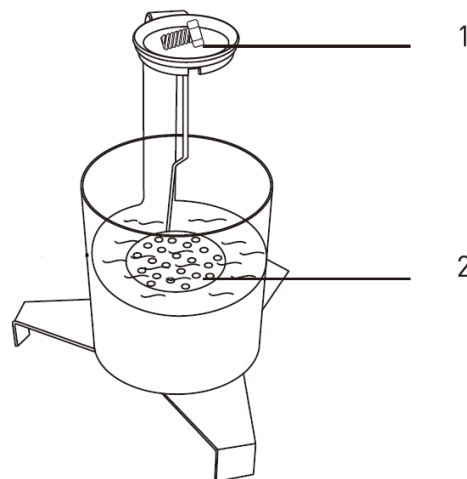
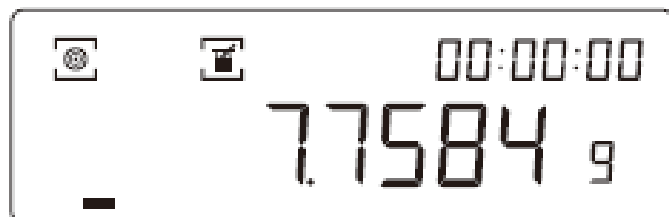

- j. Hold "PRINT" to exit the density results
- k. Repeat the configuration steps 9.4 a, b and c explained before until appears again on screen the value "-dEn-0-", press "TARE" to exit the function of density determination.

9.5 Dynamic Weighing

- a. To configure this function on your scale, hold down the "ON" button from the weighing interface to access the main menu.
- b. Keep holding it until the screen displays "SET-5"

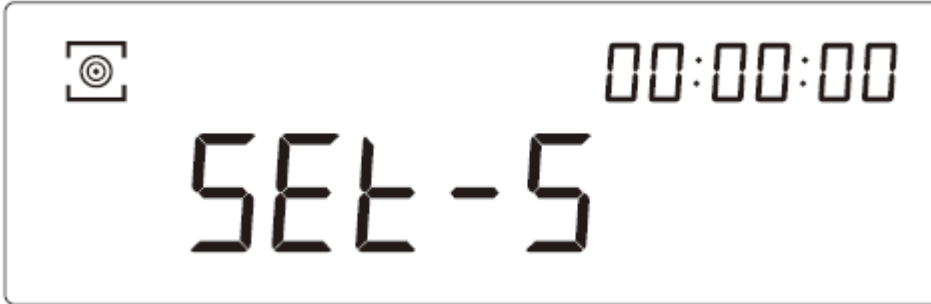

Note:

Due to the animals often moving constantly during handling, we use the term "frequency" in this dynamic weighing function to refer to the number of times the scale will record the weight of the animal, for example, "-COU-10-" will record the weight of the animal 10 times and provide the average as a result.

- c. Press and hold "PRINT" to enter the configuration for repetitions of the dynamic weighing function. The screen will display "-COU-*".
- d. Press and hold 'PRINT' again to configure the repetitions

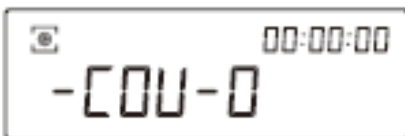

-COU-0-
close dynamic weighing

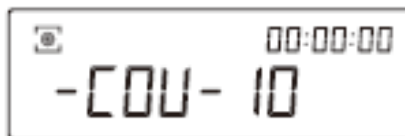

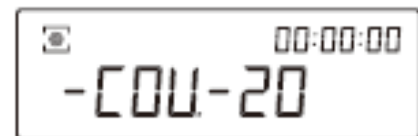

-COU-10-
start sampling 10 times



-COU-20-
start sampling 20 times

- e. Press "TARE" to save the setting and exit, the screen will show:



- f. Place the sample on the plate.
- g. Hold down "PRINT" for +3 seconds and the symbol  will flash, indicating that dynamic weighing has started.
- h. When  stops flashing, the dynamic weighing of the sample will be completed, displaying the result



- i. Hold "PRINT" to exit
- j. Follow the steps 9.5 to previously described in this manual, select "-dEn-0-" to exit the dynamic weighing function.

9.6 Baude rate setting

- a. Press and hold "ON" from the weighing interface to access the main menu.
- b. When the screen displays SET-F, release the button.

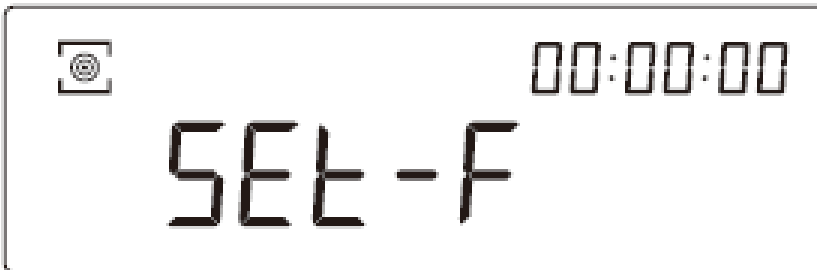

- c. Hold down "PRINT" to enter the Baud rate configuration; the screen will display "F-****."
- d. Hold down "PRINT" to choose the Baud rate; the screen will display:



F-1200 baud rate 1200



F-2400 baud rate 2400

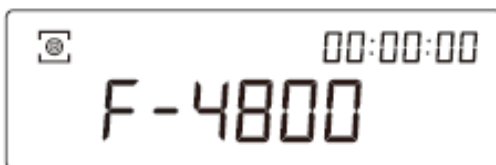

F-4800 baud rate 4800

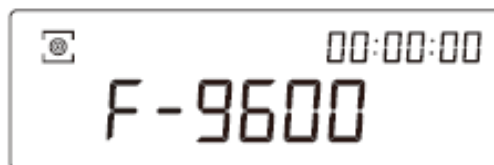

F-9600 baud rate 9600

- e. Press "TARE" to save the settings and exit.

9.7 Print setting

- a. Hold down "ON" from the weighing interface to access the main menu.
- b. When the screen displays "SET-P," release the button.

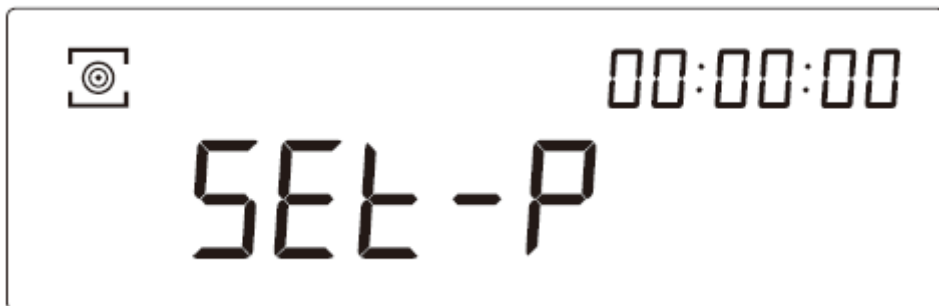

- c. Press and hold "PRINT" to enter the printing configuration; the screen will display "-Prt-*-".
- d. Press "PRINT" again to choose the printing model.

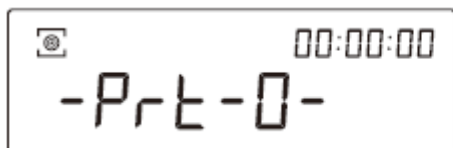

-Prt-0- press "PRINT"

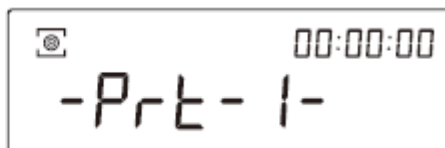

-Prt-1- Interval 0.5s, continuously printing

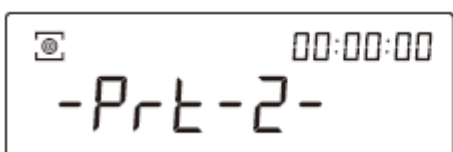

-Prt-2- interval 1s, continuously printing

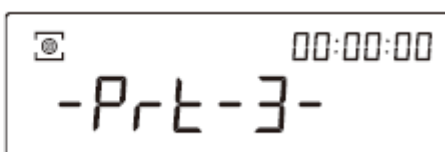

-Prt-3- Interval 2s, continuously printing

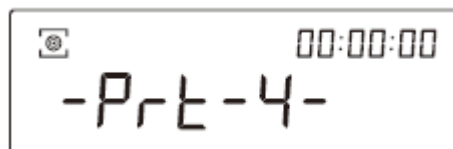

-Prt-4- Interval 3s, continuously printing

- e. Press "TARE" to save the settings and exit

9.8 Sensitivity setting

- a. Hold down "ON" from the weighing interface to access the main menu.
- b. Until "SET-A" is displayed on the screen.

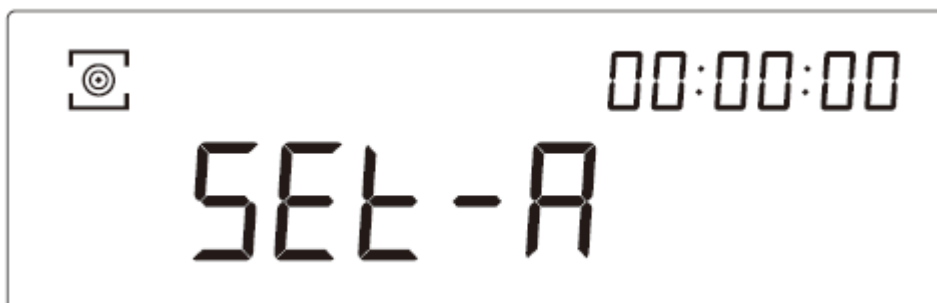

- c. Hold "PRINT" to enter the sensitivity configuration; the screen should display "-ASD-*-".

d. Continue holding "PRINT" to set the sensitivity; the screen will display



-ASD-0- highest sensitivity



-ASD-1- high sensitivity



-ASD-2- medium sensitivity



-ASD-3-

e. Press "TARE" to save the settings and exit.



Note:

The default factory sensitivity is "-ASD-3-", suitable for most usage environments. Higher sensitivity requires special conditions and environment. We do not recommend adjusting sensitivity unless you have the appropriate weighing conditions.

9.9 Filter level setting

- a. Hold "ON" button from the weighing interface to access the main menu.
- b. Until "SET-1" is displayed on the screen, release the button

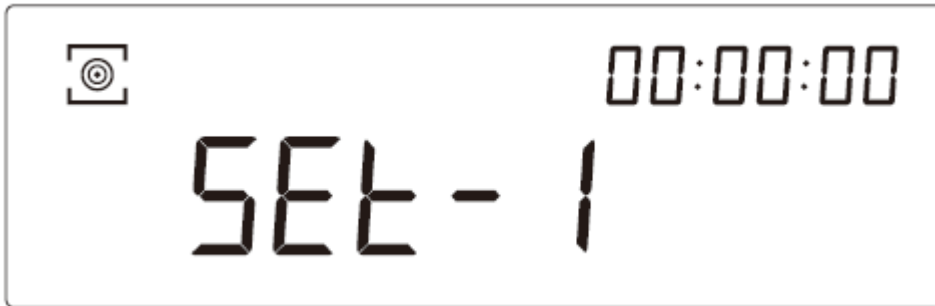

- c. Hold down "PRINT" to enter the filter level selection menu; the screen will display "-Int-*-".
- d. Keep holding "PRINT" to configure the filter level:

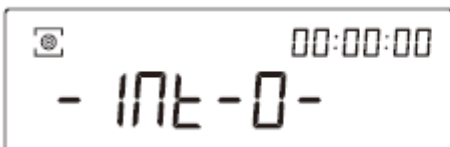

-Int-0- Highest filter level

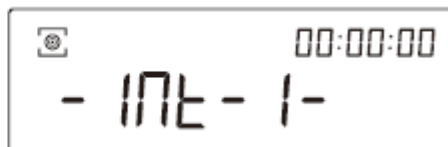

-Int-1- High filter level

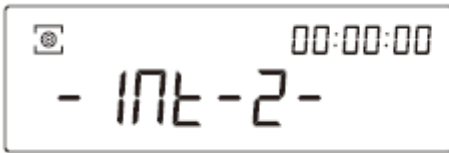

-Int-2- Medium filter level

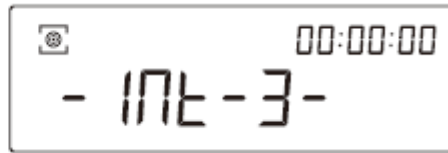

-Int-3- Low filter level

- e. Press "TARE" to save the settings and exit



Note:

The filter level is the internal calculation time of the scale; the factory setting is "-Int-2-". We do not recommend adjusting the filter level without expert supervision.

9.10 Time setting

- a. Press and hold "ON" from the weighing interface to access the main menu.
- b. Until "SET-T" is displayed on the screen, release the button.

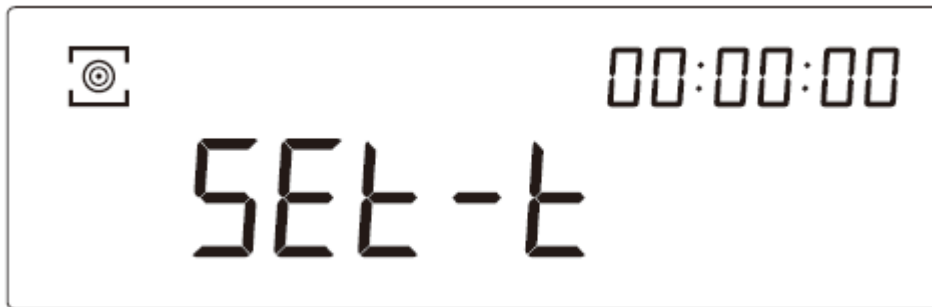

- c. Press and hold "PRINT" to enter the time configuration; the screen will display "-CLOC-*-".
- d. Press and hold the "PRINT" button again to configure the time; the screen will display:

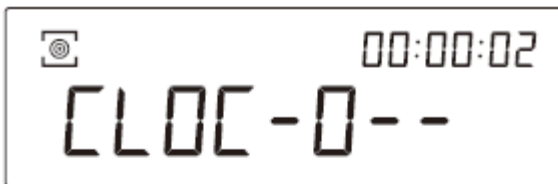

a. -CLOC-0- second

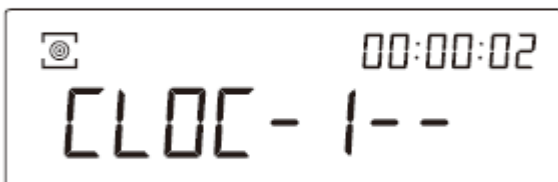

b. -CLOC-1- minute

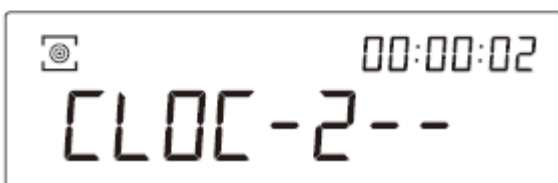

c. -CLOC-2- hour

- e. Press "CAL" to increase the time units, and "ON" to decrease them.
- f. Press "TARE" to save and exit.

10. Interface

Interface RS232 Conection

Balance (9 pins)	PC/Printer (9 pins)
RXD (Input)	2.....2
TXD (Output)	3.....3
GND (Ground)	5.....5

-The default Baud rate is 9600 bps (see section 9.6 Baud Rate Configuration).

-Data Format: 10 bits, 0 start bit, 1 stop bit, 8 digits (ASCII code) - No adjustment for even and odd numbers.

-Data Output: By default, in continuous mode. The data output mode can be changed to pulse mode, time mode, and continuous mode.

-Data Output Format:

1	2	3	4	5	6	7	8	9	10	11	12	13	14	15
Type or data	data	data	data	data	Data or dot	Data or dot	data	data	data	unit	unit	unit	return	Line feed

11. Troubleshooting

Problem	Cause	Solution
No display	No power supply Fuse damaged Power adaptor is damaged	Plug in the adapter. Change the fuse. Change the AC adapter. If the problem persists, send the balance to the Technical Service Repair
Unstable display	Bad working conditions; Air flow; Unstable support of the balance on the working surface. The power exceeds the permissible value and is unstable. Static electricity	Improve the working conditions. Close the windshield. Remove the weighing pan and clean the balance Surface. Connect the balance to power supply 110-220 V AC. Eliminate the static electricity
Poor accuracy	Improper calibration. The weight of the recipient has not been tared. Big temperature difference. The balance is not horizontal	Calibrate the balance. Tare the recipient. Change the device ubication. Adjust the levelling feet of the device

12. Technical Data

Metria Plus: -internal cal. 220 g -external cal. 220 g	
Model	
Capacity	0-220 g
Readability	0,1 mg
Stabilization time	2 s
Pre heating	30 - 60 min
Weighing units	g/oz/ct/mg
Minimum weight	0,1 mg
Repeatability	±0,1 mg
Linearity	±0,2 mg
Interface	RS232
Pan size	Ø 90mm
Balance size	310 x 212x 350 mm
N.W.	5500g
Power	AC110V-240V

Nota importante para los aparatos electrónicos vendidos en España

Instrucciones sobre la protección del medio ambiente y la eliminación de aparatos electrónicos:



Los aparatos eléctricos y electrónicos marcados con este símbolo no pueden ser eliminados en forma de residuos urbanos.

De conformidad con la Directiva 2012/19/UE, los usuarios de la Unión Europea de aparatos eléctricos y electrónicos, tienen la posibilidad de devolver sus RAEE para su eliminación al distribuidor o fabricante del equipo después de la compra de uno nuevo. La eliminación ilegal de aparatos eléctricos y electrónicos es castigada con multa administrativa.

Remarque importante pour les appareils électroniques vendus en France

Informations sur la protection du milieu environnemental et élimination des déchets électroniques :



Les appareils électriques et électroniques portant ce symbole ne peuvent pas être jetés dans les décharges.

En réponse à la réglementation, Labbox remplit ses obligations relatives à la fin de vie des équipements électriques de laboratoire qu'il met sur le marché en finançant la filière de recyclage de ecosystem dédiée aux DEEE Pro qui les reprend gratuitement (plus d'informations sur www.ecosystem.eco).

L'élimination illégale d'appareils électriques et électroniques est punie d'amende administrative.

Nota importante per le apparecchiature elettroniche vendute in Italia

Istruzioni sulla protezione ambientale e sullo smaltimento dei dispositivi elettronici:



Le apparecchiature elettriche ed elettroniche contrassegnate con questo simbolo non possono essere smaltite come rifiuti urbani.

In conformità con la Direttiva 2012/19 / UE, gli utenti dell'Unione Europea di apparecchiature elettriche ed elettroniche hanno la possibilità di restituire i propri RAEE per lo smaltimento al distributore o al produttore di apparecchiature dopo averne acquistato uno nuovo. La rimozione illegale di apparecchiature elettriche ed elettroniche è punibile con una sanzione amministrativa.

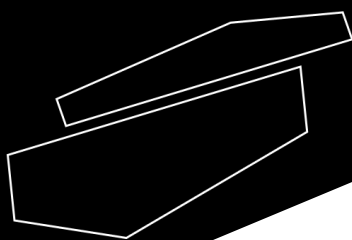

www.labbox.com